

ТЕХНИЧЕСКА ХАРАКТЕРИСТИКА

АНКЕР – FBN II - за леки закрепвания, с гайка, поцинкован, с удължена резба

Bolt FBN II

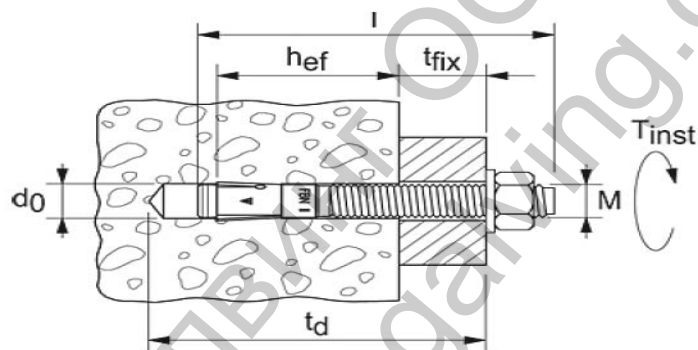







Характеристики: Одобрен за не ронлив бетон от C20/25 до C50/60































Подходящи също за бетон С 12/15, както и натурален камък с гъста, плътна, компактна структура.

За монтаж на : стоманени конструкции, конзоли, стълбища, машини, порти, фасади, дървени конструкции, елементи на прозорци, парапети, перила и др.

Размери - виж. Стр 2

| Type | Art.-No. | ETA DIBt | Imprint on head | drill d ₀ [mm] | max. usable length t _{fix} [mm] | anchorage depth h _{ef} [mm] | min. drill-hole depth for through fixings t _d [mm] | anchor length l [mm] | thread [Ø x length] | qty. per box pcs. |
|---------------------|----------|---|-----------------|---------------------------------|--|--|--|----------------------------|------------------------|----------------------|
| FBN II 8/5 (8x66) | 040662 |  | A | 8 | 5 | 40 | 61 | 66 | M 8 x 34 | 50 |
| FBN II 8/10 (8x71) | 040664 |  | B | 8 | 10 | 40 | 66 | 71 | M 8 x 39 | 50 |
| FBN II 8/20 (8x81) | 040669 |  | D | 8 | 20 | 40 | 76 | 81 | M 8 x 49 | 50 |
| FBN II 8/30 (8x91) | 040700 |  | F | 8 | 30 | 40 | 86 | 91 | M 8 x 59 | 50 |
| FBN II 8/50 (8x111) | 040771 |  | K | 8 | 50 | 40 | 106 | 111 | M 8 x 79 | 50 |
| FBN II 8/70 (8x131) | 040777 |  | M | 8 | 70 | 40 | 126 | 131 | M 8 x 99 | 20 |

| Type | Art.-No. | ETA DIBt | Imprint on head | drill d_o [mm] | max. usable length t_{fix} [mm] | anchorage depth h_{ef} [mm] | min. drill-hole depth for through fixings t_d [mm] | anchor length l [mm] | thread [Ø x length] | qty. per box pcs. |
|------------------------|----------|-------------|-----------------|------------------------|---|-------------------------------------|---|------------------------------|------------------------|----------------------|
| FBN II 8/100 (8x161) | 040783 | ■ | P | 8 | 100 | 40 | 156 | 161 | M 8 x 100 | 20 |
| FBN II 10/10 (10x86) | 040827 | ■ | B | 10 | 10 | 50 | 78 | 86 | M 10 x 46 | 50 |
| FBN II 10/20 (10x96) | 040851 | ■ | D | 10 | 20 | 50 | 88 | 96 | M 10 x 56 | 50 |
| FBN II 10/30 (10x106) | 040854 | ■ | F | 10 | 30 | 50 | 98 | 106 | M 10 x 66 | 50 |
| FBN II 10/50 (10x126) | 040855 | ■ | K | 10 | 50 | 50 | 118 | 126 | M 10 x 86 | 20 |
| FBN II 10/70 (10x146) | 040931 | ■ | M | 10 | 70 | 50 | 138 | 146 | M 10 x 100 | 20 |
| FBN II 10/100 (10x176) | 040943 | ■ | P | 10 | 100 | 50 | 168 | 176 | M 10 x 100 | 20 |
| FBN II 10/140 (10x216) | 040944 | ■ | S | 10 | 140 | 50 | 208 | 216 | M 10 x 100 | 20 |
| FBN II 10/160 (10x236) | 040945 | ■ | T | 10 | 160 | 50 | 228 | 236 | M 10 x 100 | 20 |
| FBN II 12/10 (12x106) | 040950 | ■ | B | 12 | 10 | 65 | 95 | 106 | M 12 x 59 | 20 |
| FBN II 12/20 (12x116) | 044558 | ■ | D | 12 | 20 | 65 | 105 | 116 | M 12 x 69 | 20 |
| FBN II 12/30 (12x126) | 045263 | ■ | F | 12 | 30 | 65 | 115 | 126 | M 12 x 79 | 20 |
| FBN II 12/50 (12x146) | 045264 | ■ | K | 12 | 50 | 65 | 135 | 146 | M 12 x 99 | 20 |
| FBN II 12/80 (12x176) | 045265 | ■ | N | 12 | 80 | 65 | 165 | 176 | M 12 x 129 | 20 |
| FBN II 12/100 (12x196) | 045266 | ■ | P | 12 | 100 | 65 | 185 | 196 | M 12 x 149 | 20 |
| FBN II 12/120 (12x216) | 045267 | ■ | R | 12 | 120 | 65 | 205 | 216 | M 12 x 169 | 20 |
| FBN II 12/140 (12x236) | 045268 | ■ | S | 12 | 140 | 65 | 225 | 236 | M 12 x 189 | 20 |
| FBN II 12/160 (12x256) | 045269 | ■ | T | 12 | 160 | 65 | 245 | 256 | M 12 x 100 | 20 |
| FBN II 16/25 (16x145) | 045564 | ■ | E | 16 | 25 | 80 | 129 | 145 | M 16 x 89 | 10 |
| FBN II 16/50 (16x170) | 045565 | ■ | K | 16 | 50 | 80 | 154 | 170 | M 16 x 114 | 10 |
| FBN II 16/80 (16x200) | 045566 | ■ | N | 16 | 80 | 80 | 184 | 200 | M 16 x 144 | 10 |
| FBN II 16/100 (16x220) | 045567 | ■ | P | 16 | 100 | 80 | 204 | 220 | M 16 x 164 | 10 |
| FBN II 16/140 (16x260) | 045568 | ■ | S | 16 | 140 | 80 | 244 | 260 | M 16 x 100 | 10 |
| FBN II 16/160 (16x280) | 045569 | ■ | T | 16 | 160 | 80 | 264 | 280 | M 16 x 100 | 10 |
| FBN II 16/200 (16x320) | 045570 | ■ | V | 16 | 200 | 80 | 304 | 320 | M 16 x 100 | 10 |
| FBN II 20/30 (20x184) | 045573 | ■ | F | 20 | 30 | 105 | 165 | 184 | M 20 x 90 | 10 |
| FBN II 20/60 (20x214) | 045574 | ■ | L | 20 | 60 | 105 | 195 | 214 | M 20 x 90 | 10 |
| FBN II 20/80 (20x234) | 045575 | ■ | M | 20 | 80 | 105 | 215 | 234 | M 20 x 90 | 10 |
| FBN II 20/120 (20x274) | 045576 | ■ | R | 20 | 120 | 105 | 255 | 274 | M 20 x 90 | 10 |
| FBN II 8/5 K (8x56) | 040806 | ■ | -A- | 8 | 5 | 30 | 51 | 56 | M 8 x 24 | 50 |

| Type | Art.-No. |  ETA  DIBt | Imprint on head | drill d_o [mm] | max. usable length t_{fix} [mm] | anchorage depth h_{ef} [mm] | min. drill-hole depth for through fixings t_d [mm] | anchor length l [mm] | thread [Ø x length] | qty. per box pcs. |
|---------------------------|----------|---|-----------------|------------------------|---|-------------------------------------|---|------------------------------|------------------------|----------------------|
| FBN II 8/10 K (8x81) | 040807 |  | -B- | 8 | 10 | 30 | 56 | 61 | M 8 x 29 | 50 |
| FBN II 8/30 K (8x81) | 040826 |  | -F- | 8 | 30 | 30 | 76 | 81 | M 8 x 49 | 50 |
| FBN II 10/5 K (10x71) | 040946 |  | -A- | 10 | 5 | 40 | 63 | 71 | M 10 x 31 | 50 |
| FBN II 10/10 K (10x76) | 040947 |  | -B- | 10 | 10 | 40 | 68 | 76 | M 10 x 36 | 50 |
| FBN II 10/30 K (10x96) | 040948 |  | -F- | 10 | 30 | 40 | 88 | 96 | M 10 x 56 | 50 |
| FBN II 12/5 K (12x86) | 045272 |  | -A- | 12 | 5 | 50 | 75 | 86 | M 12 x 39 | 20 |
| FBN II 12/10 K (12x91) | 045273 |  | -B- | 12 | 10 | 50 | 80 | 91 | M 12 x 44 | 20 |
| FBN II 12/30 K (12x111) | 045274 |  | -F- | 12 | 30 | 50 | 100 | 111 | M 12 x 64 | 20 |
| FBN II 16/15 K (16x120) | 045571 |  | -C- | 16 | 15 | 65 | 104 | 120 | M 16 x 64 | 10 |
| FBN II 16/25 K (16x130) | 045572 |  | -E- | 16 | 25 | 65 | 114 | 130 | M 16 x 74 | 10 |
| FBN II 20/10 K (20x139) | 045577 |  | -B- | 20 | 10 | 80 | 120 | 139 | M 20 x 50 | 10 |
| FBN II 12/80 GS (12x176) | 045578 |  | N | 12 | 80 | 65 | 165 | 176 | M 12 x 129 | 20 |
| FBN II 12/100 GS (12x196) | 045579 |  | P | 12 | 100 | 65 | 185 | 196 | M 12 x 149 | 20 |
| FBN II 12/120 GS (12x216) | 045580 |  | R | 12 | 120 | 65 | 205 | 216 | M 12 x 169 | 20 |
| FBN II 12/140 GS (12x236) | 045581 |  | S | 12 | 140 | 65 | 225 | 236 | M 12 x 189 | 10 |
| FBN II 12/160 GS (12x256) | 045583 |  | T | 12 | 160 | 65 | 245 | 256 | M 12 x 100 | 10 |
| FBN II 12/180 GS (12x276) | 045584 |  | U | 12 | 180 | 65 | 265 | 276 | M 12 x 100 | 10 |
| FBN II 12/200 GS (12x296) | 045585 |  | V | 12 | 200 | 65 | 285 | 296 | M 12 x 100 | 10 |
| FBN II 12/250 GS (12x346) | 045586 |  | W | 12 | 250 | 65 | 335 | 346 | M 12 x 100 | 10 |
| FBN II 16/80 GS (16x200) | 045587 |  | N | 16 | 80 | 80 | 184 | 200 | M 16 x 144 | 10 |
| FBN II 16/100 GS (16x220) | 045588 |  | P | 16 | 100 | 80 | 204 | 220 | M 16 x 164 | 10 |
| FBN II 16/120 GS (16x240) | 045589 |  | R | 16 | 120 | 80 | 224 | 240 | M 16 x 184 | 10 |
| FBN II 16/140 GS (16x160) | 045590 |  | S | 16 | 140 | 80 | 244 | 260 | M 16 x 100 | 10 |
| FBN II 16/160 GS (16x280) | 045591 |  | T | 16 | 160 | 80 | 264 | 280 | M 16 x 100 | 10 |
| FBN II 16/180 GS (16x300) | 045592 |  | U | 16 | 180 | 80 | 284 | 300 | M 16 x 100 | 10 |
| FBN II 16/200 GS (16x320) | 045593 |  | V | 16 | 200 | 80 | 304 | 320 | M 16 x 100 | 10 |
| FBN II 16/250 GS | 052192 |  | W | 16 | 250 | 80 | 354 | 370 | M 16 x 100 | 10 |
| FBN II 16/300 GS | 052204 |  | X | 16 | 300 | 80 | 404 | 420 | M 16 x 100 | 10 |